



Univerzálny montážny plán

Domček so sedlovou strechou

Záhradné domčeky

MICHAL ZELMAN

www.domceknazahradu.sk



DOMCEK
NAZAHRADU.SK

Počet oporných bodov podľa veľkosti pôdorysu podlahy (šírka × dĺžka)

Pôdorys o šírke 375 cm

375 x 625 cm

32 oporných bodov.

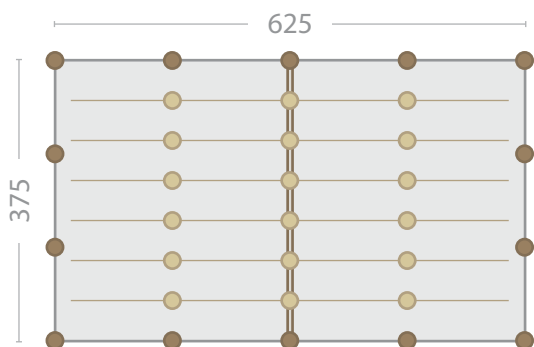

375 x 500 cm

32 oporných bodov.

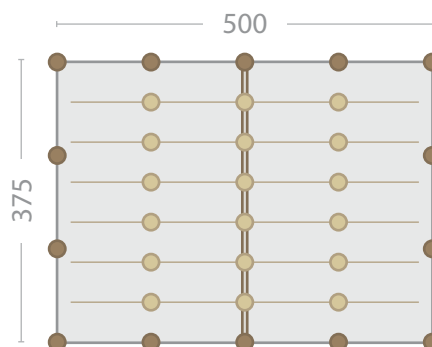

375 x 375 cm

24 oporných bodov.

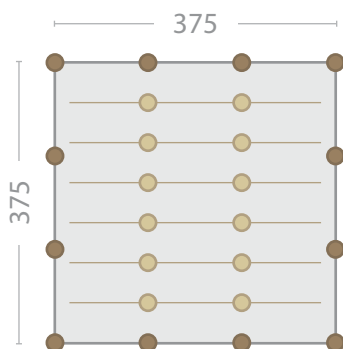

Pôdorys o šírke 300 cm

300 x 500 cm

29 oporných bodov.

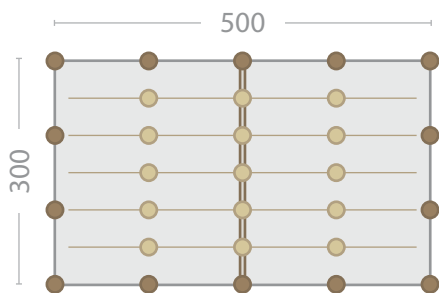

300 x 375 cm

22 oporných bodov.

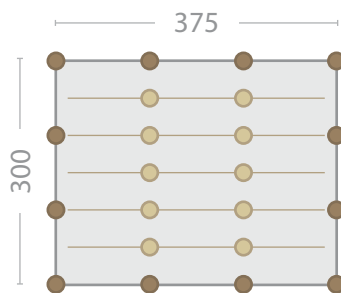

300 x 300 cm

17 oporných bodov.

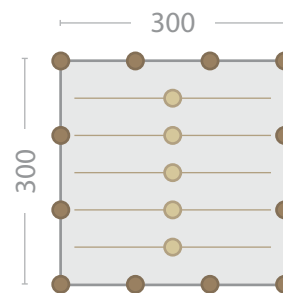

Pôdorys o šírke 250 cm (resp. 240 cm)

250 x 625 cm

22 oporných bodov.

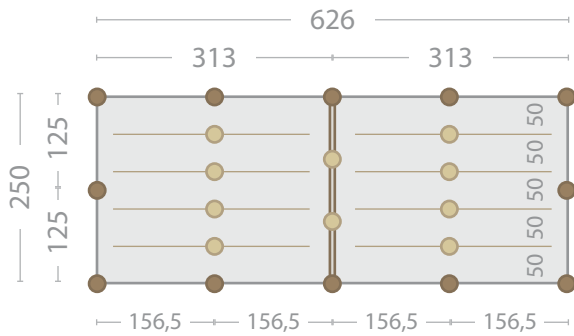

250 x 500 cm

21 oporných bodov.

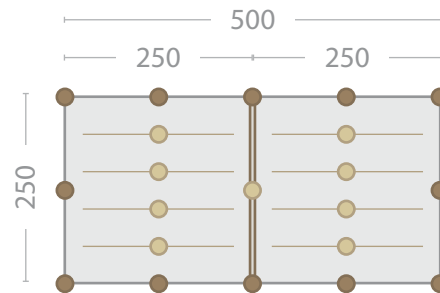

250 x 375 cm

18 oporných bodov.

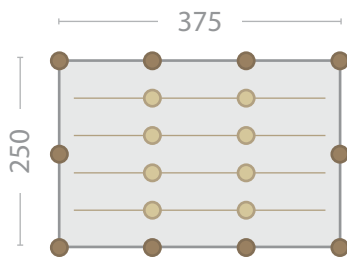

250 x 250 cm

12 oporných bodov.

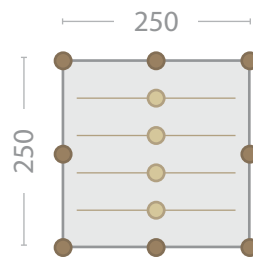

Pôdorys o šírke 125 cm

125 x 375 cm

12 oporných bodov.

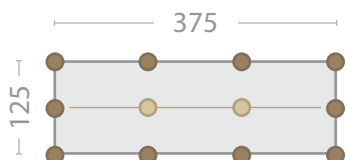

125 x 250 cm

9 oporných bodov.

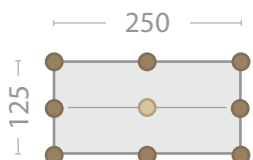

125 x 150 cm

9 oporných bodov.

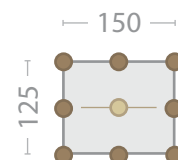

Základný rošt pre podlahu (vzorový – v závislosti na type domčeka)

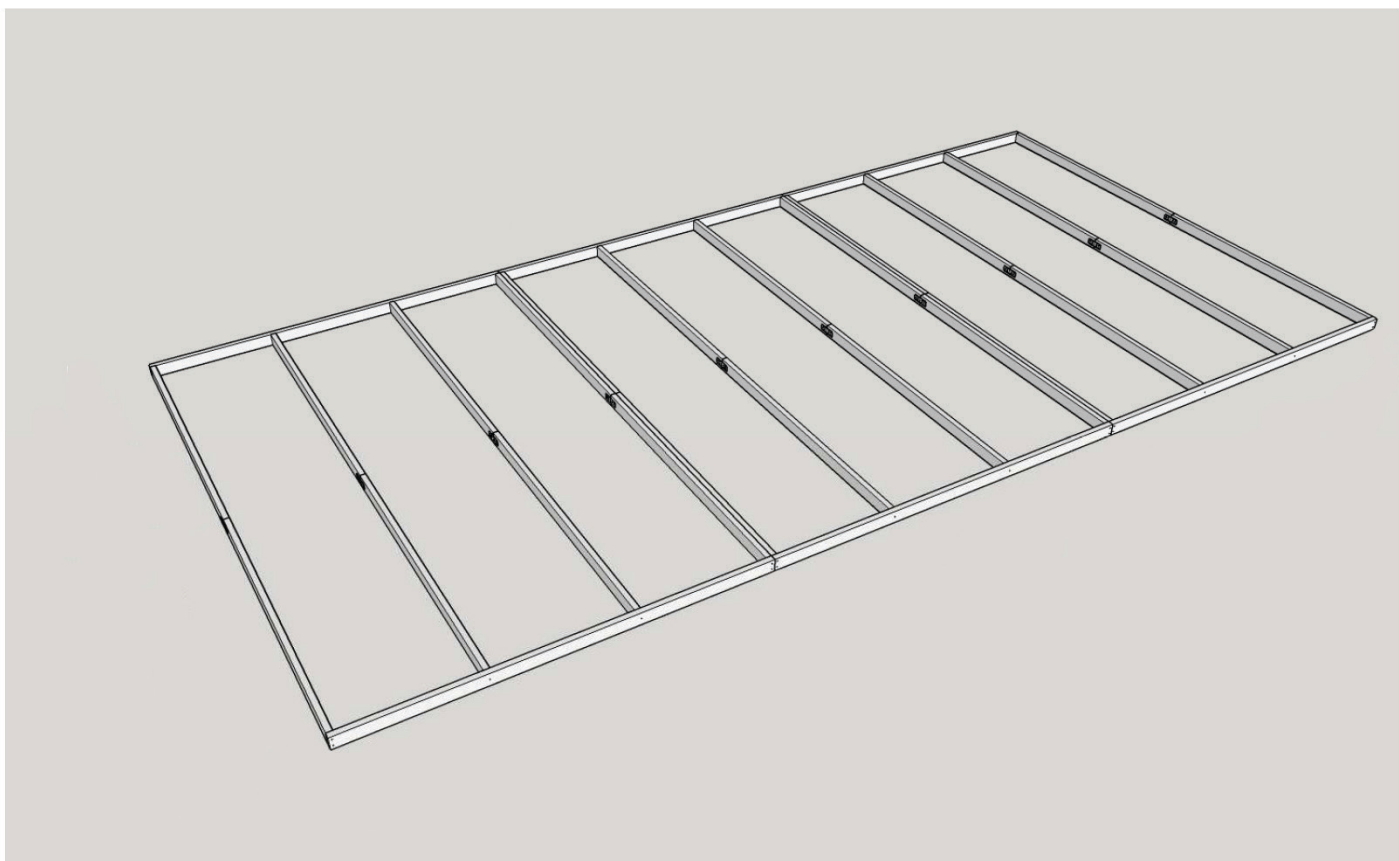
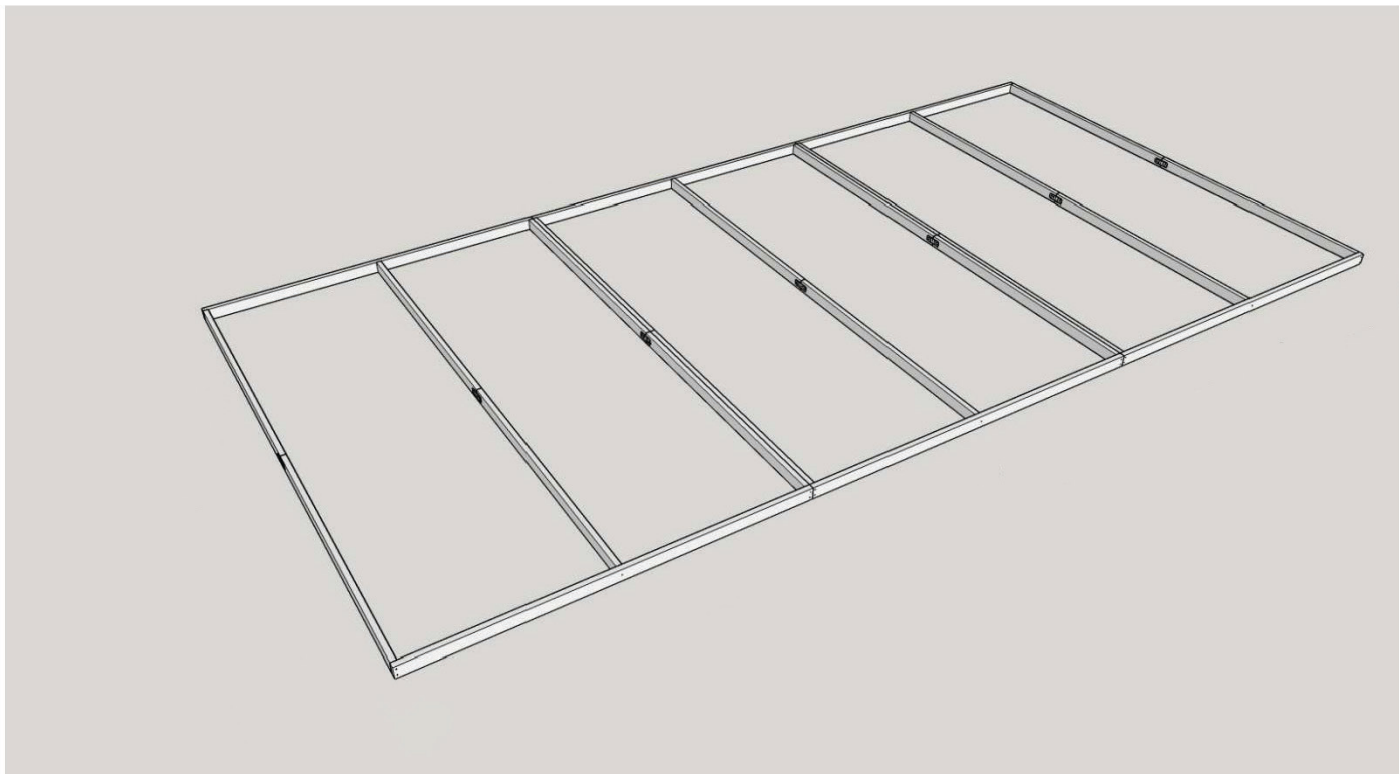

Kladenie podlahy (vzorové – v závislosti na type domčeka)

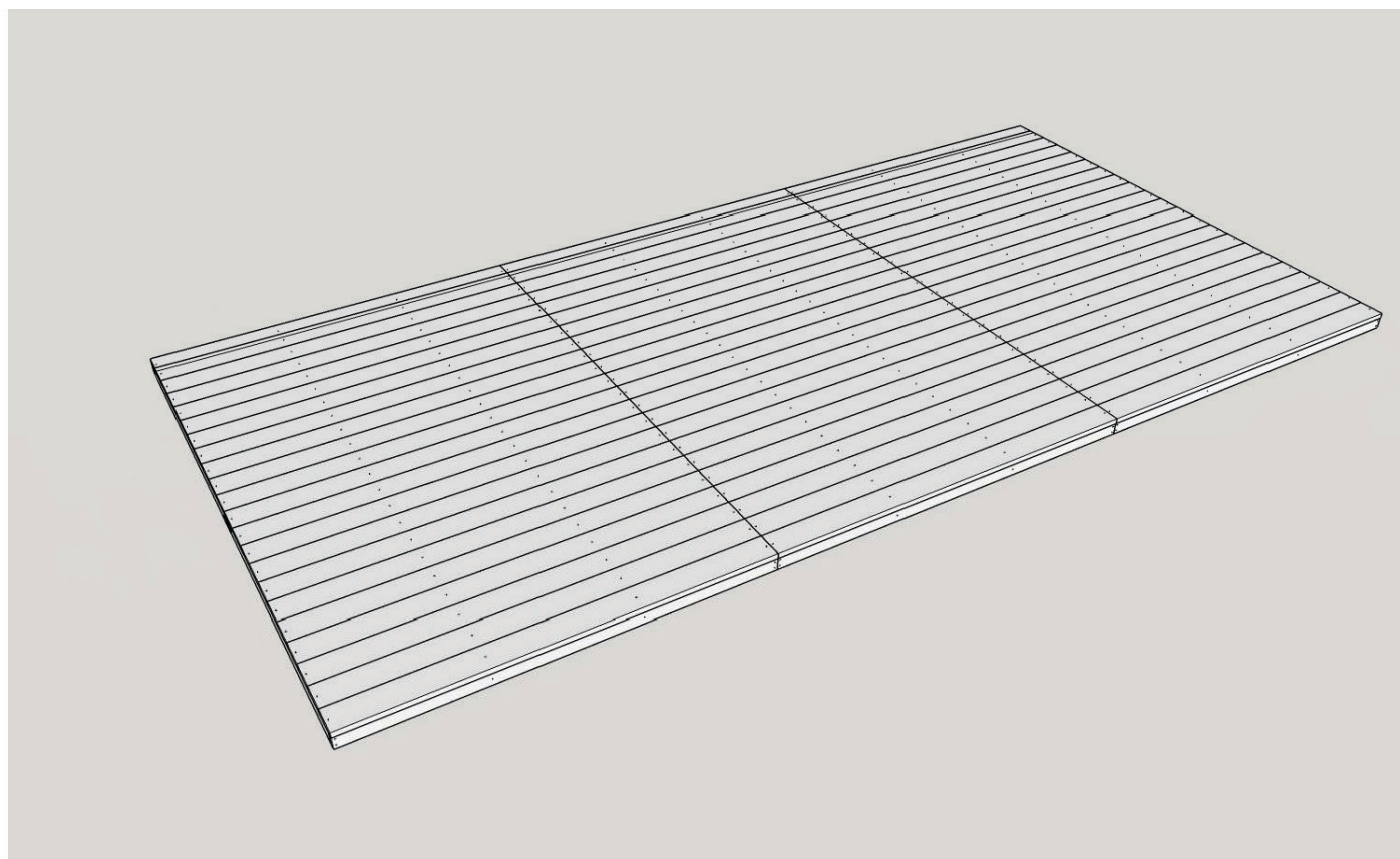
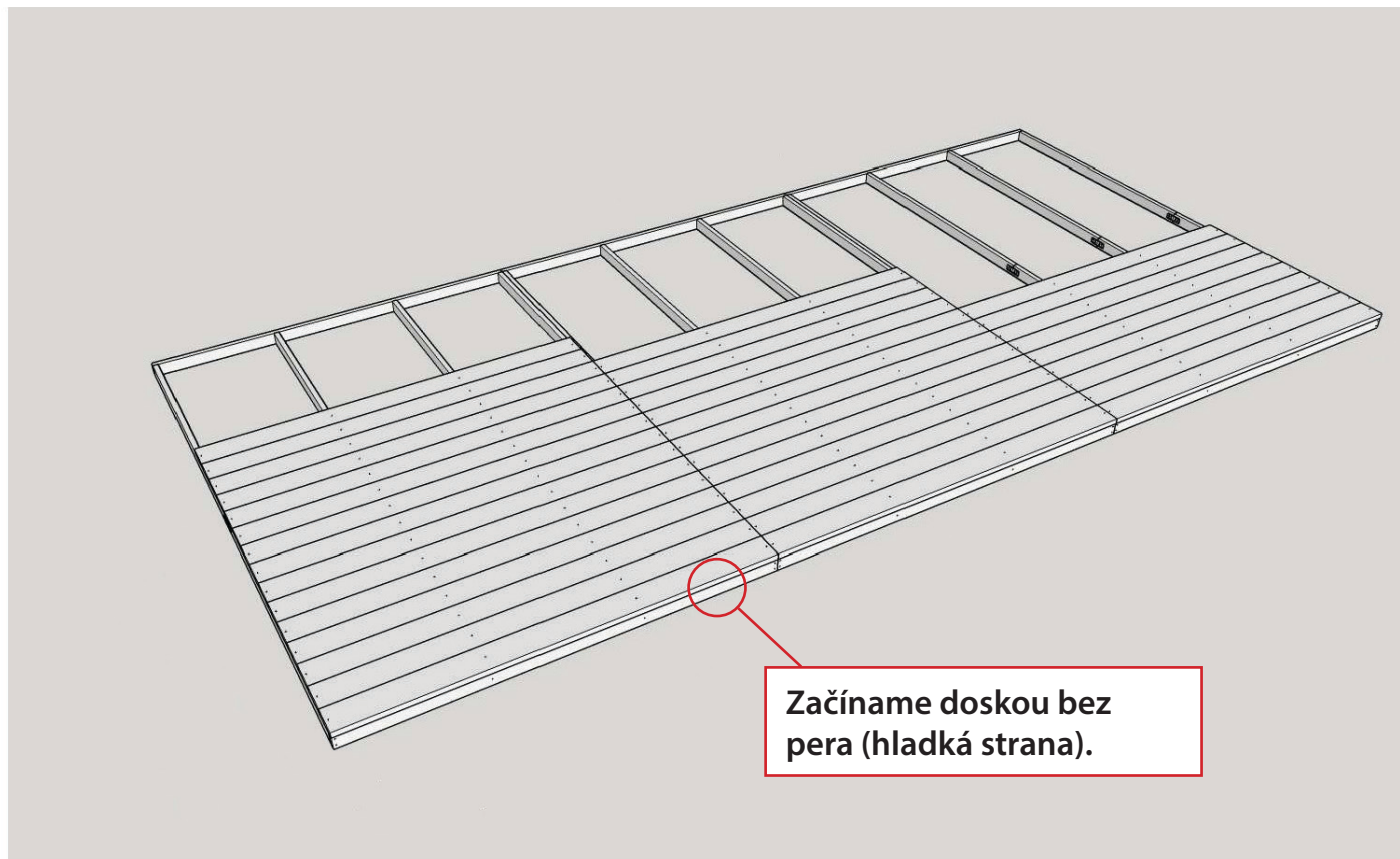

Uloženie stien domčeka

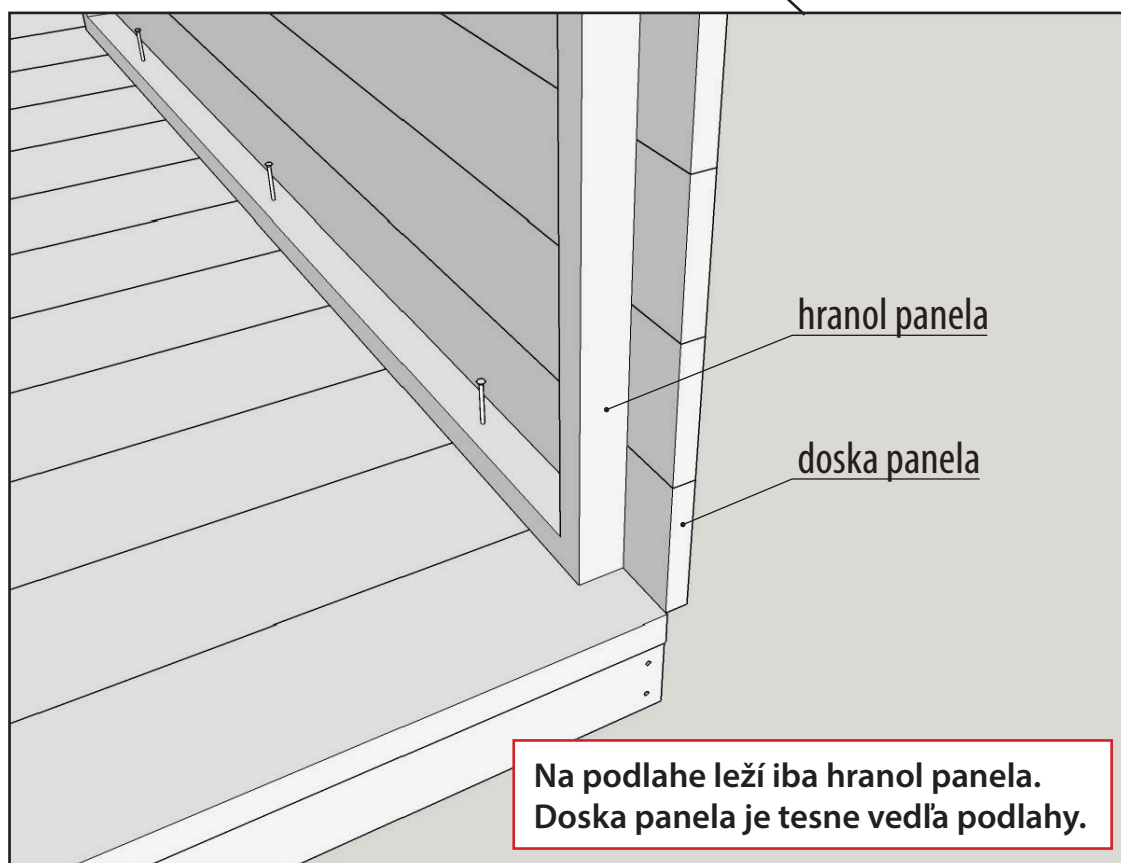
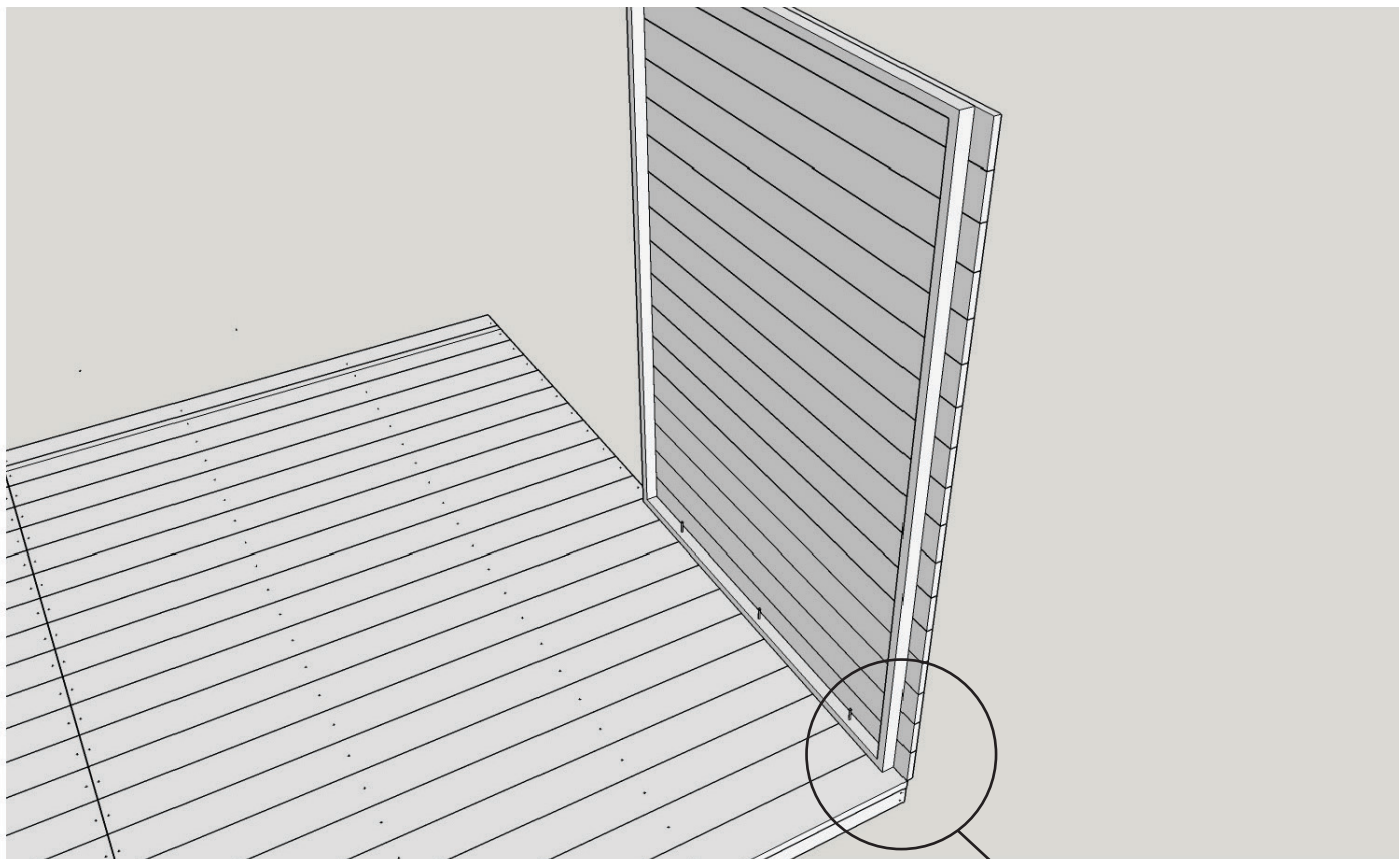

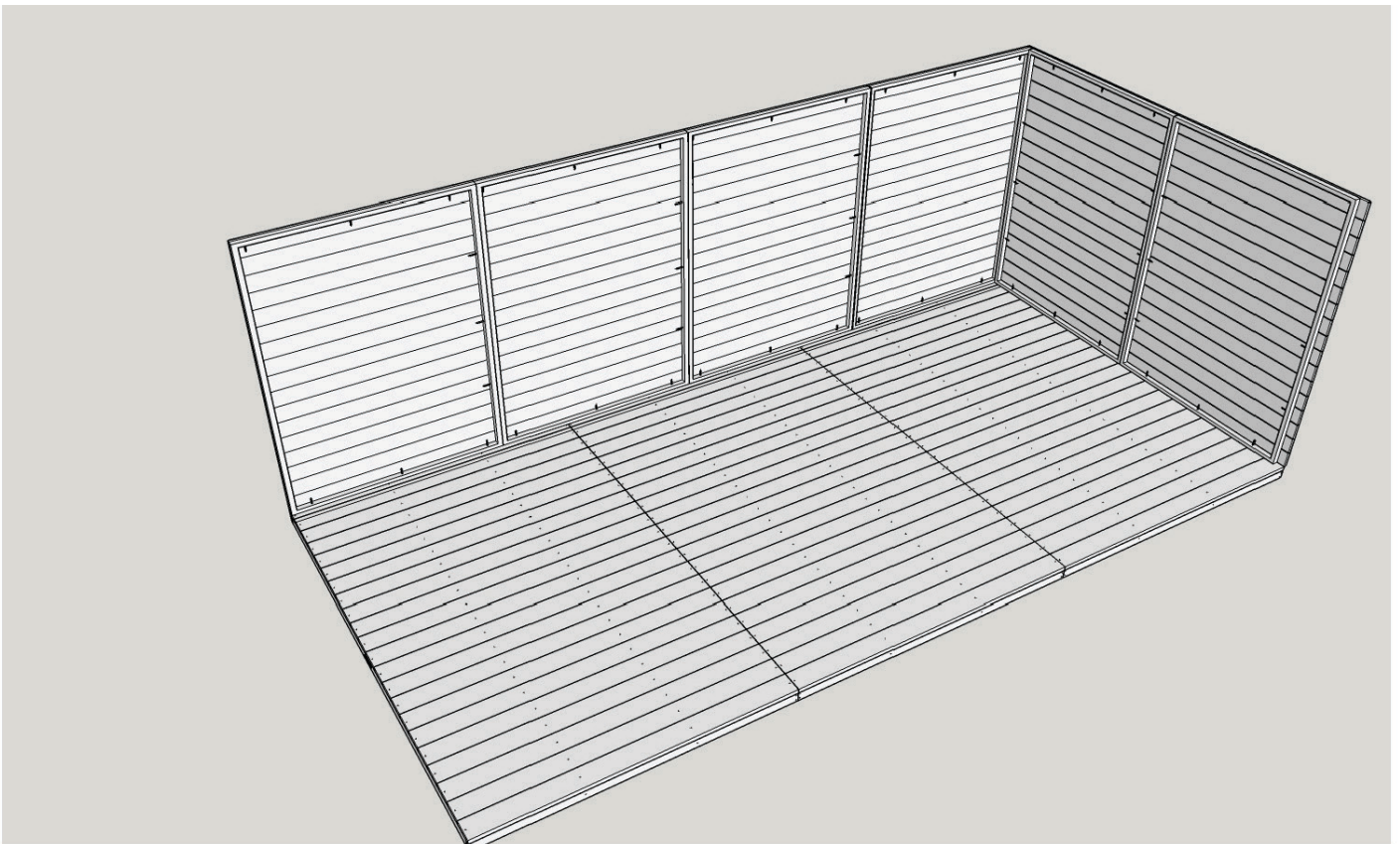
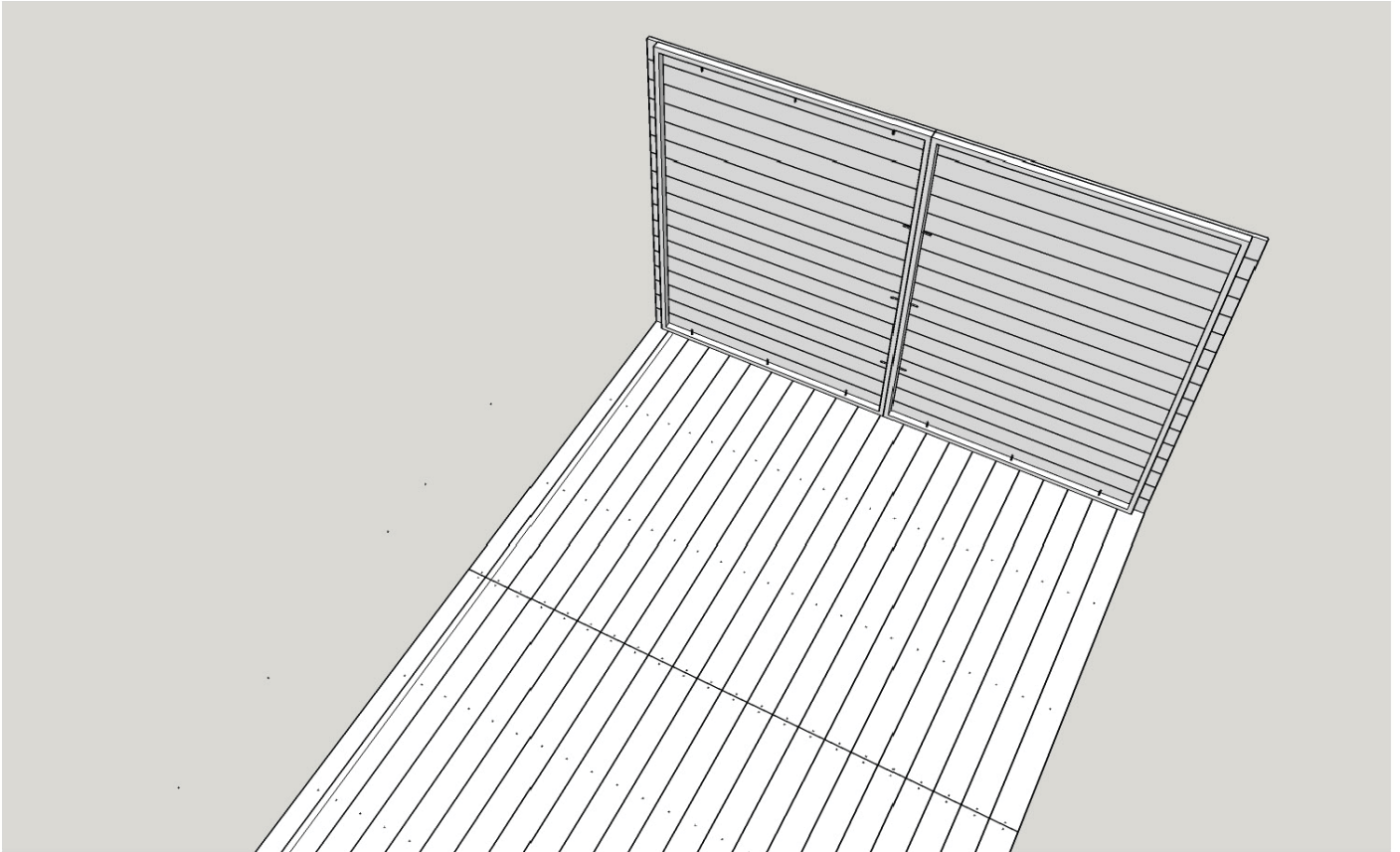

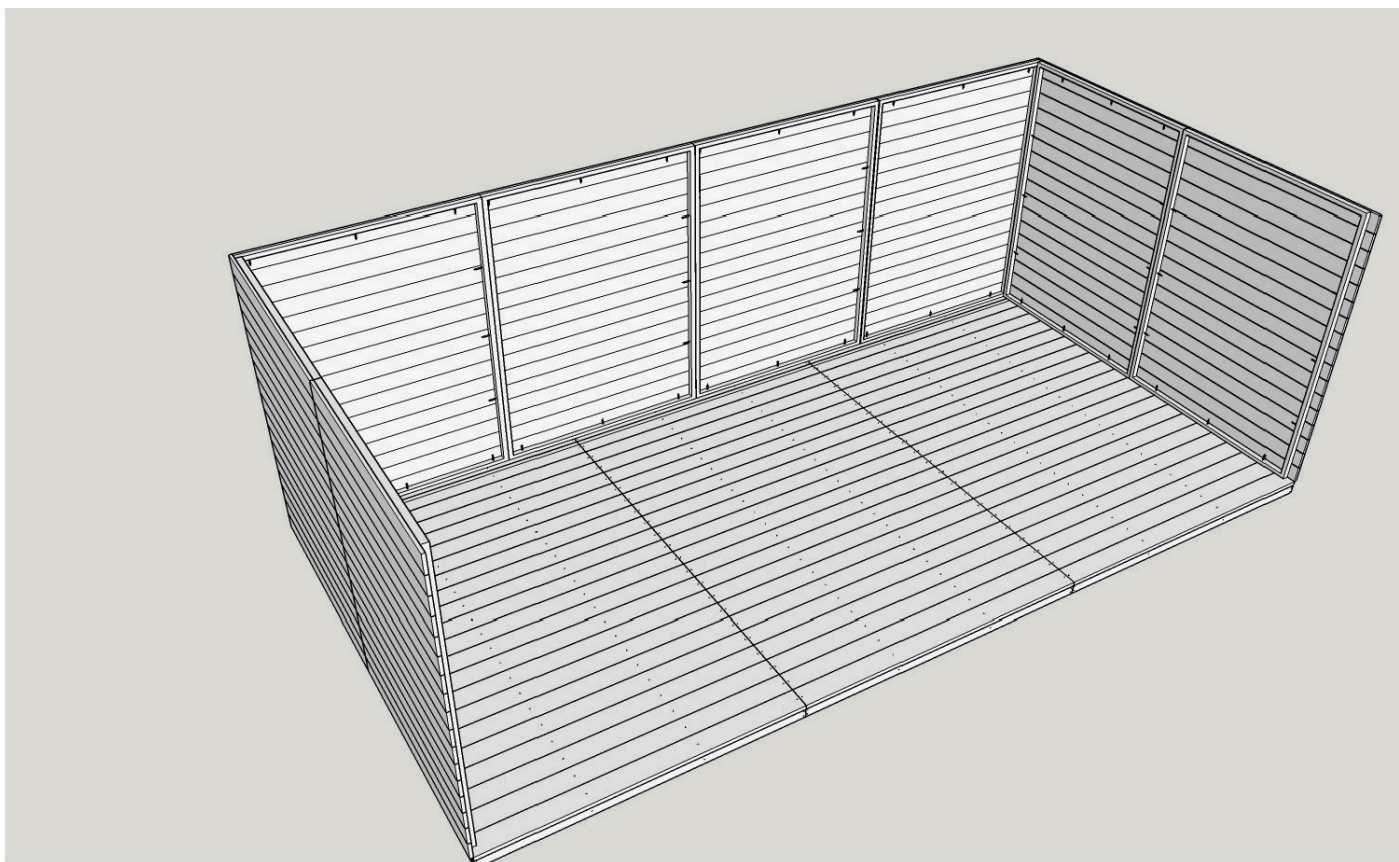
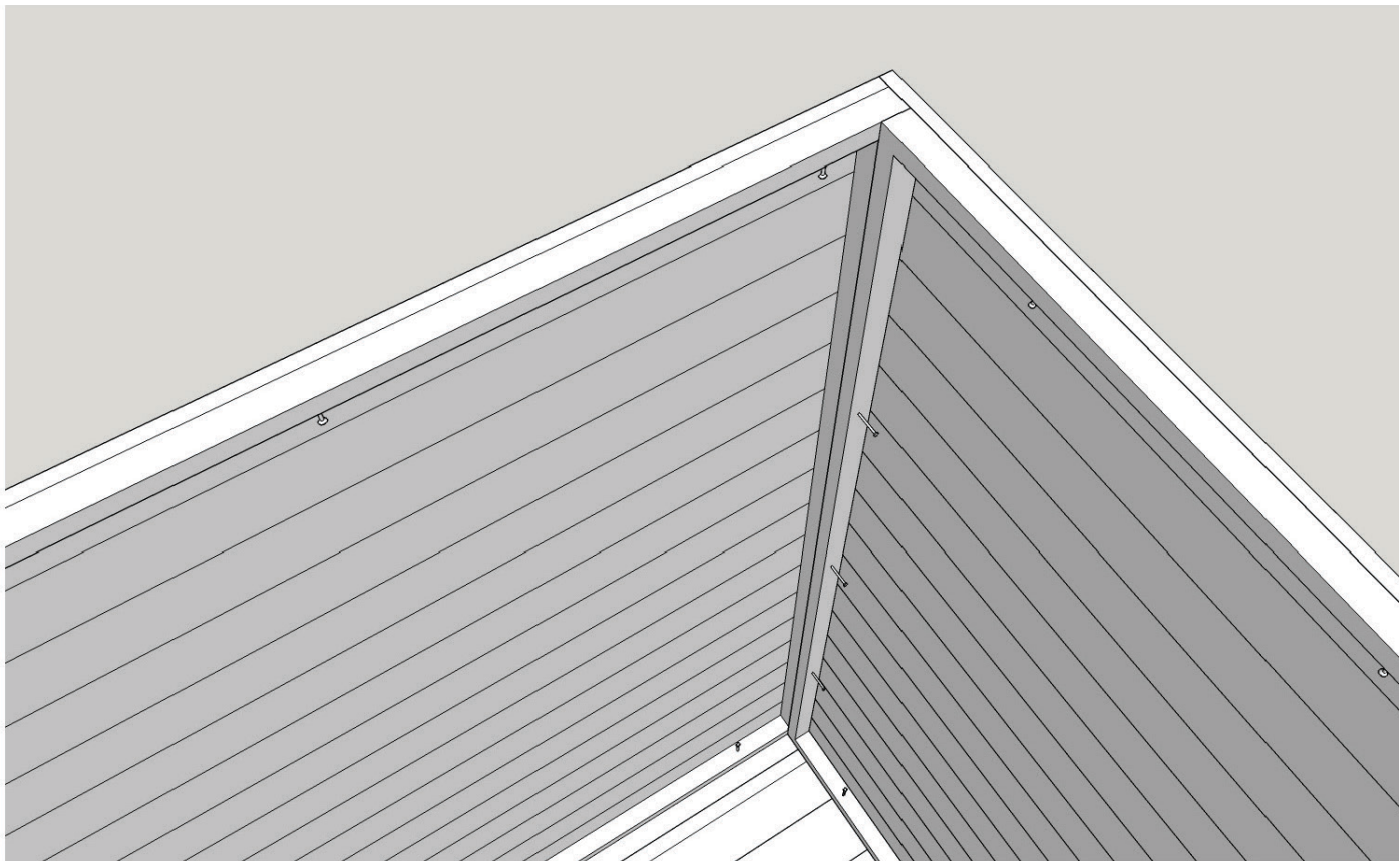

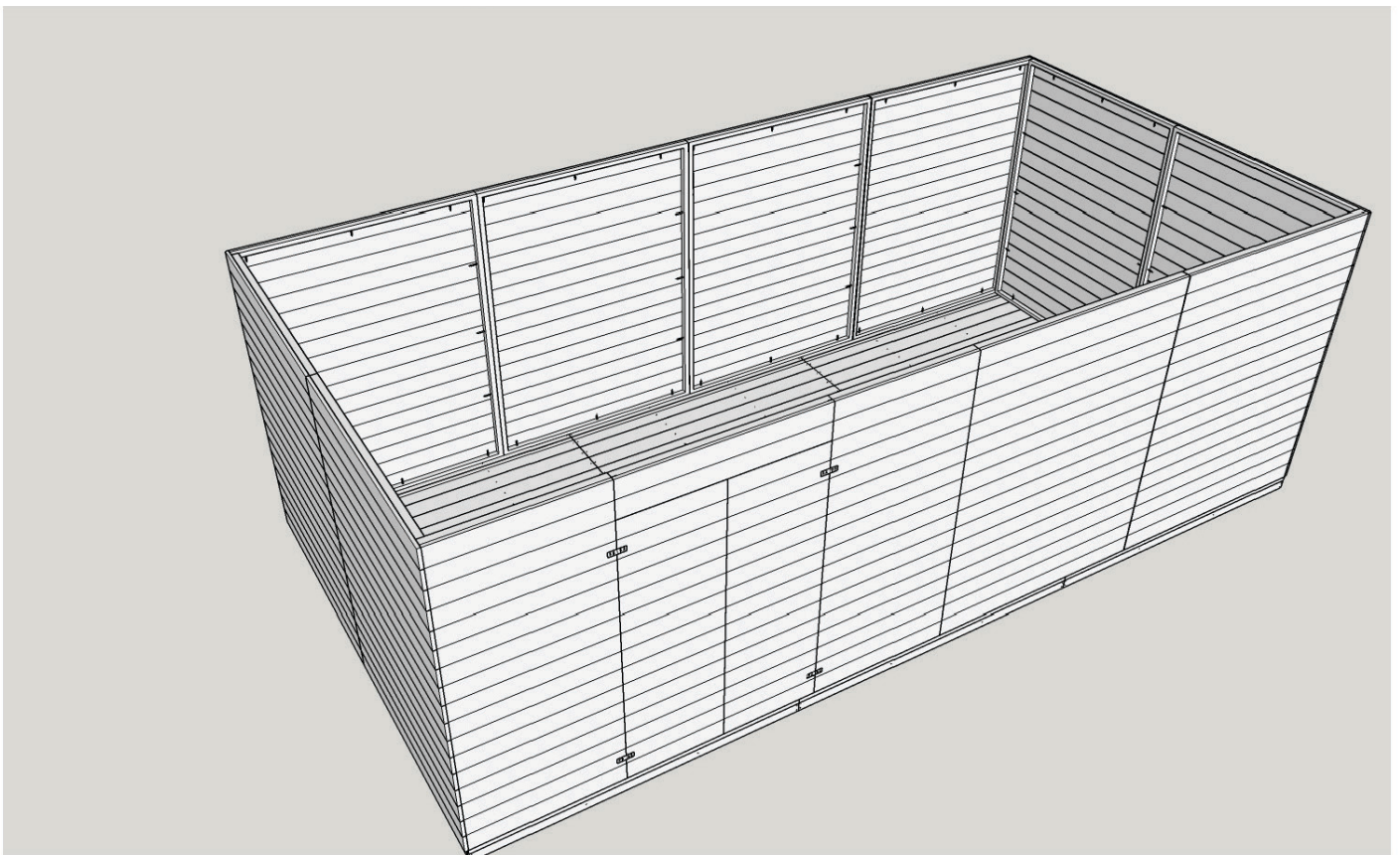
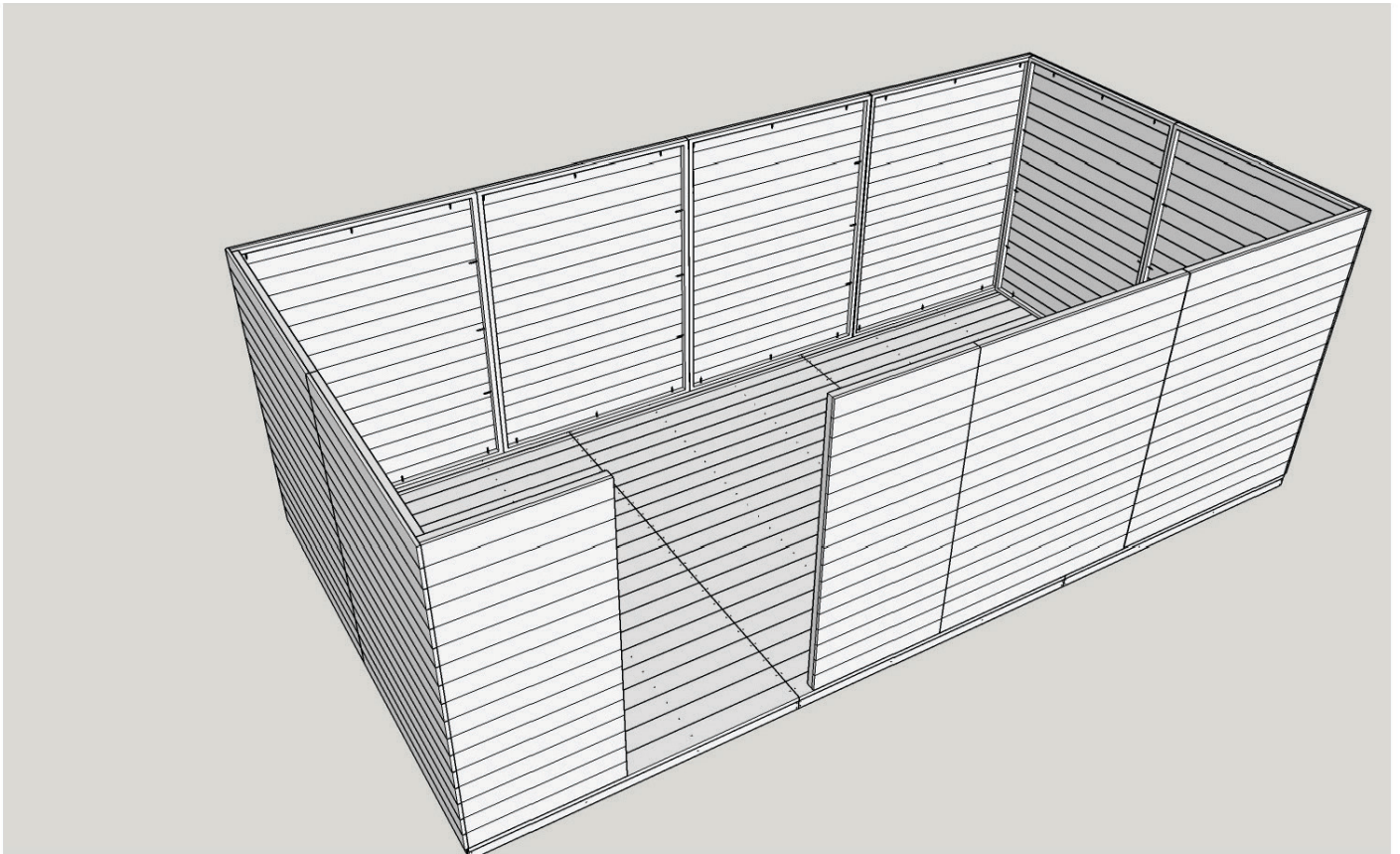

Uloženie konštrukcie strechy

Bočný trojuholník

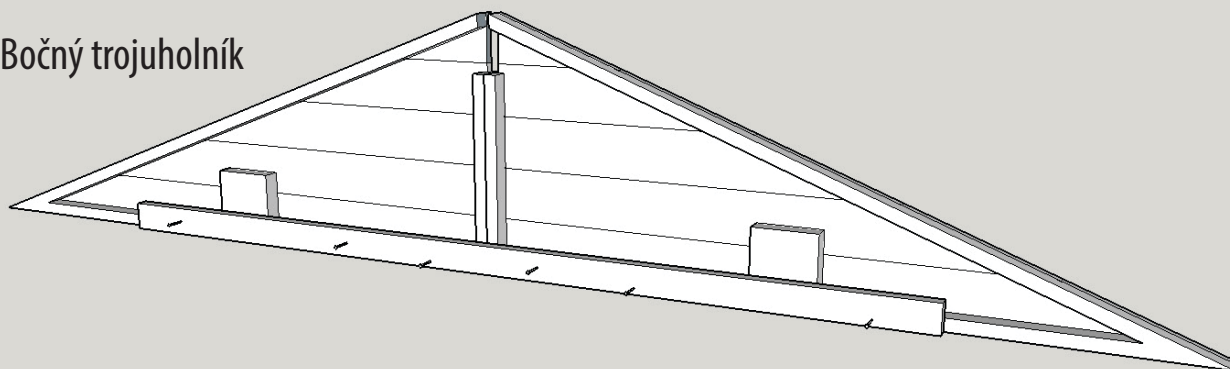

Vnútorý trojuholník

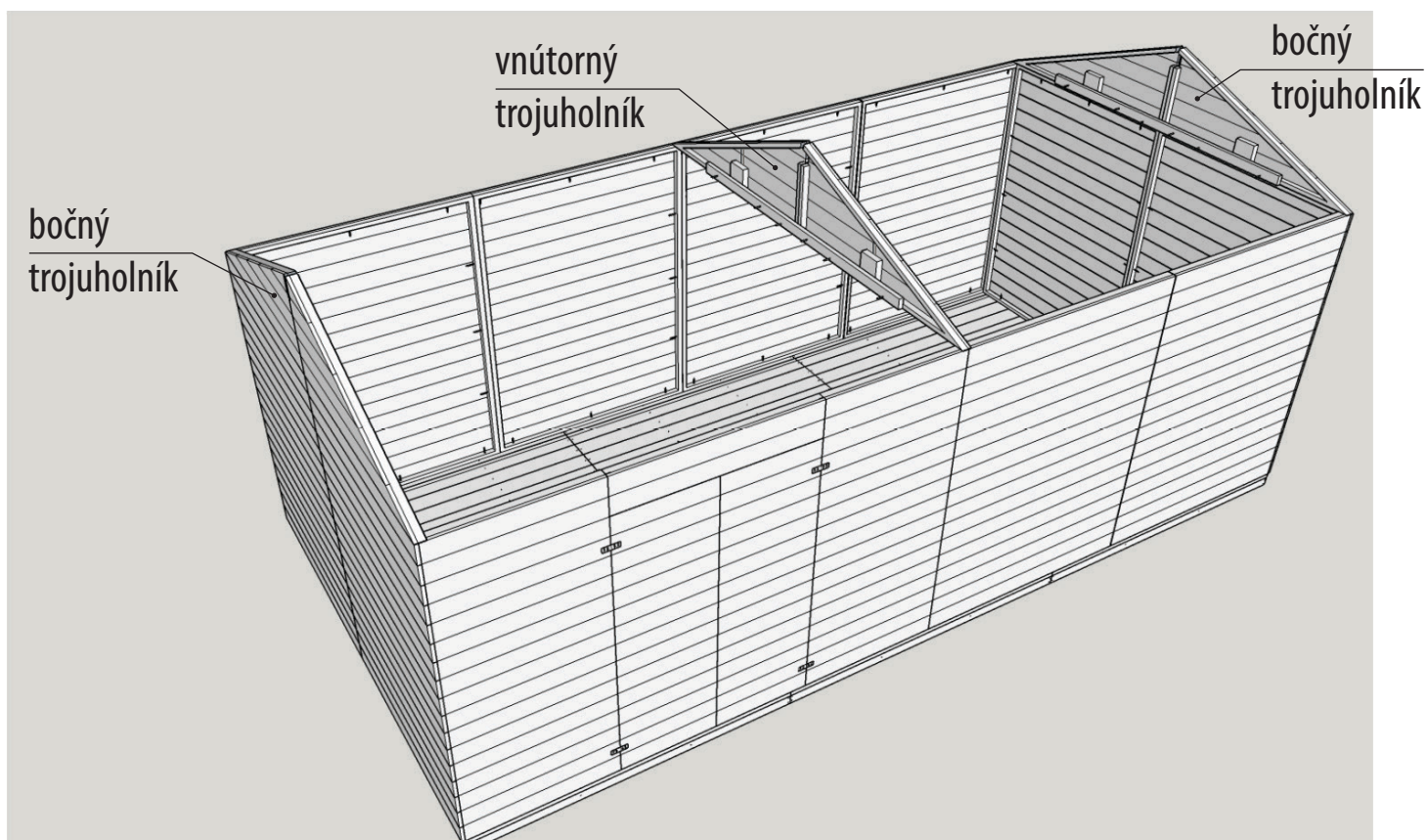
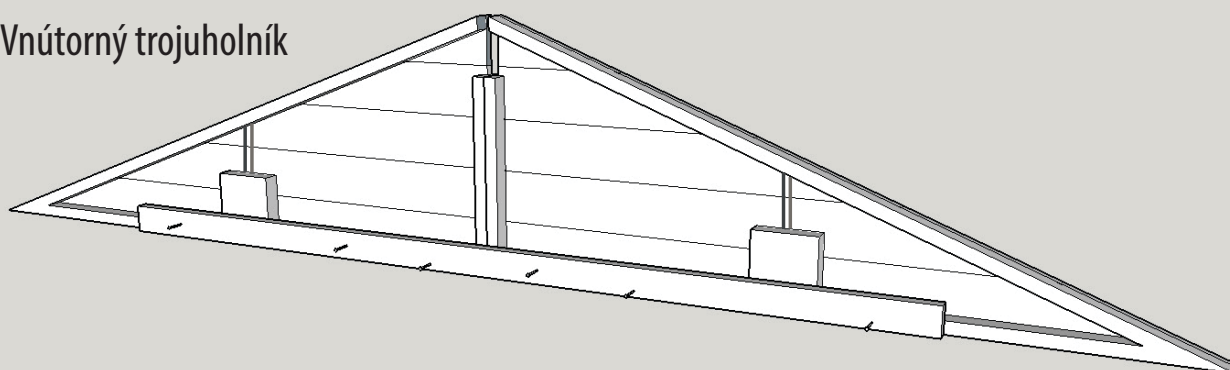

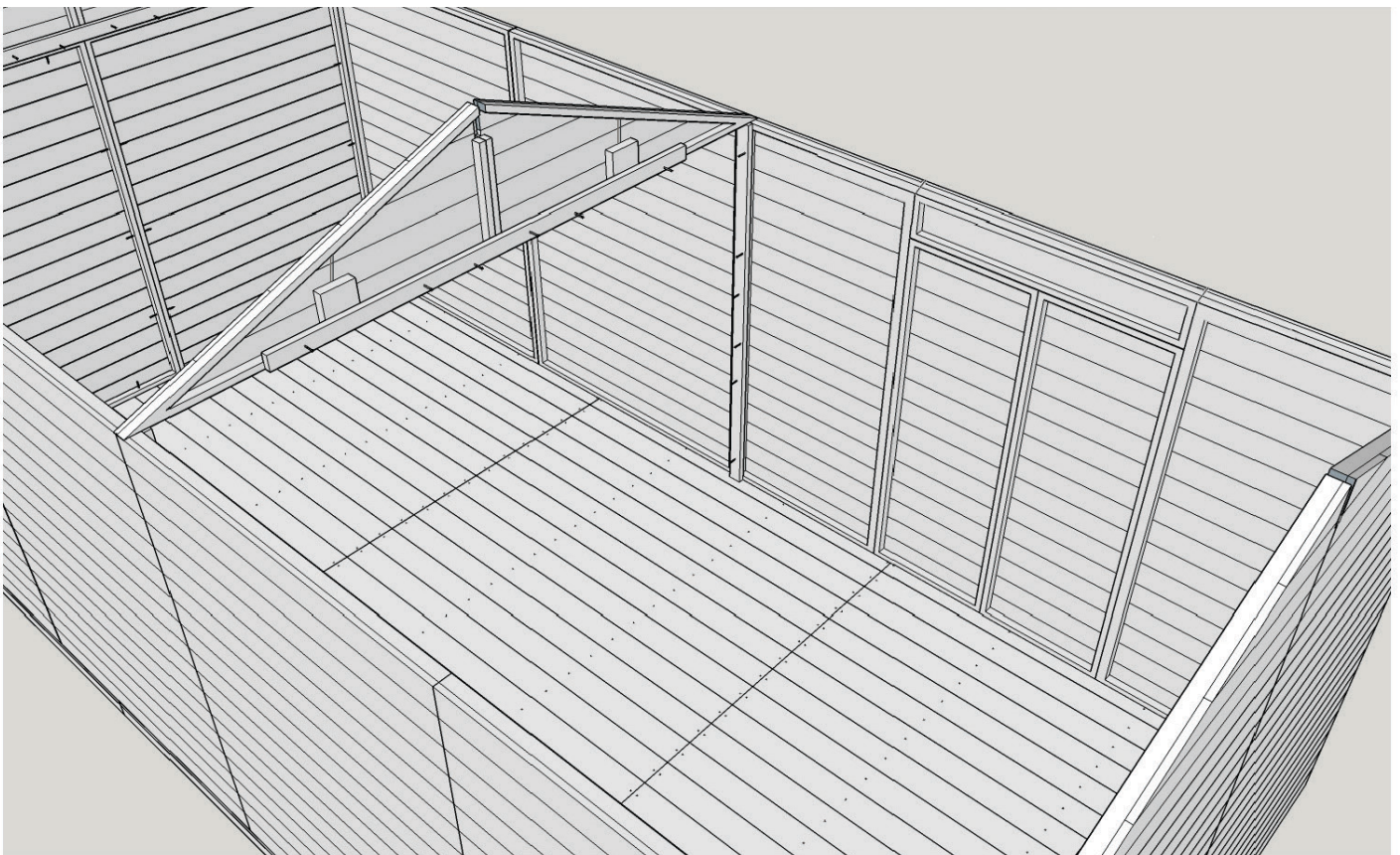
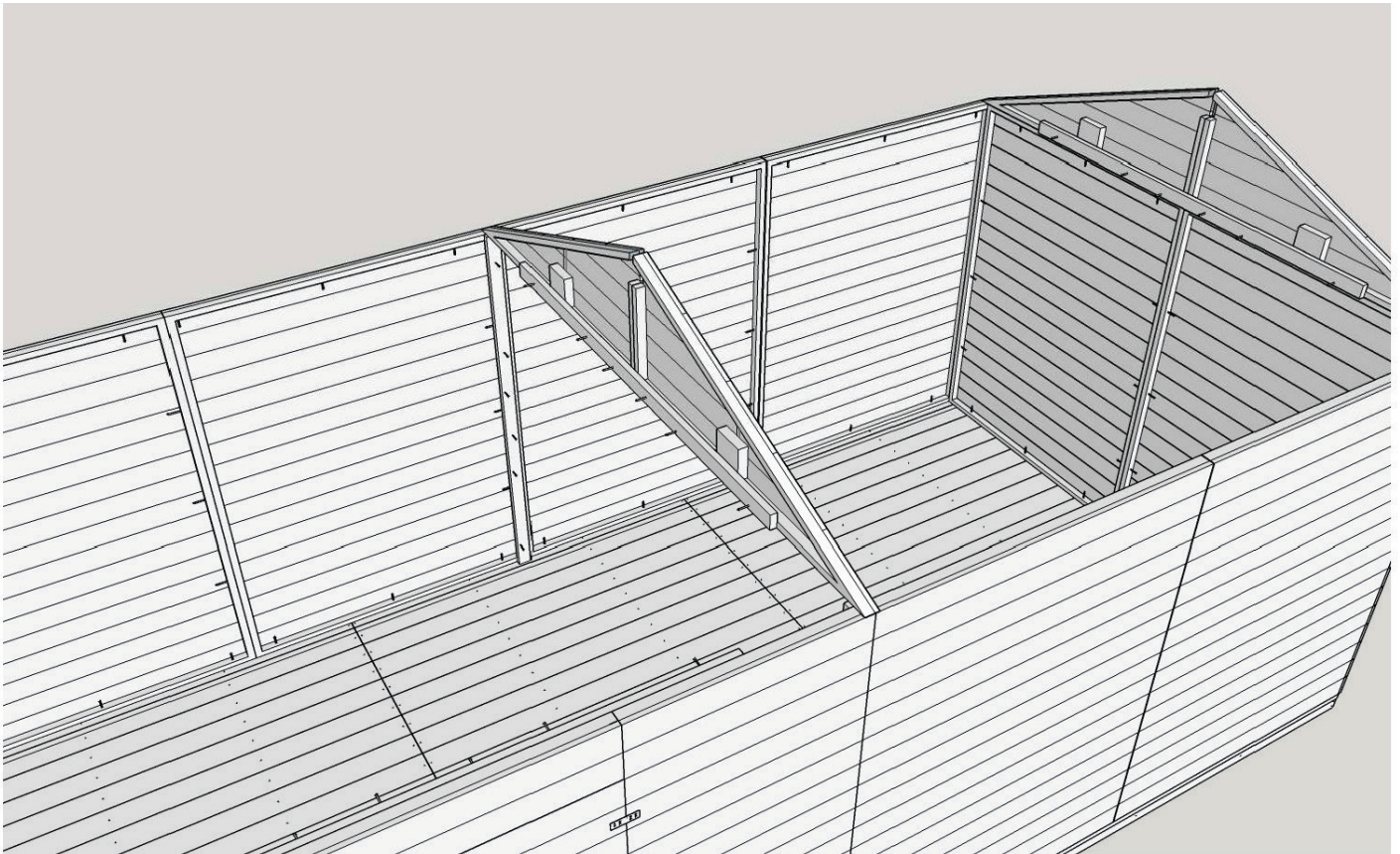

Stredová krokva

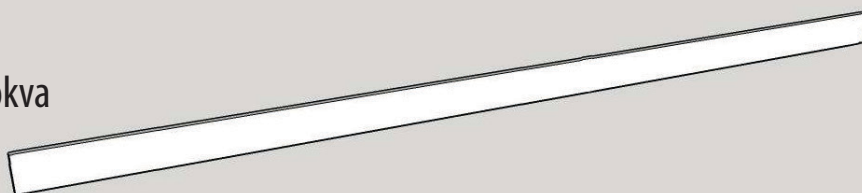

Bočná krokva

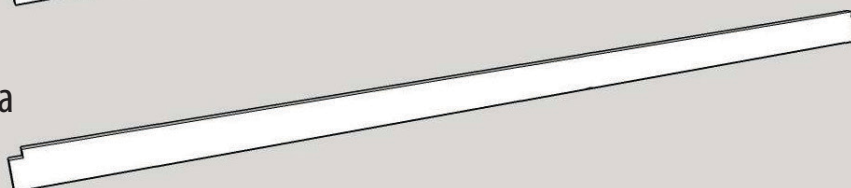

Nadstavované krokvy

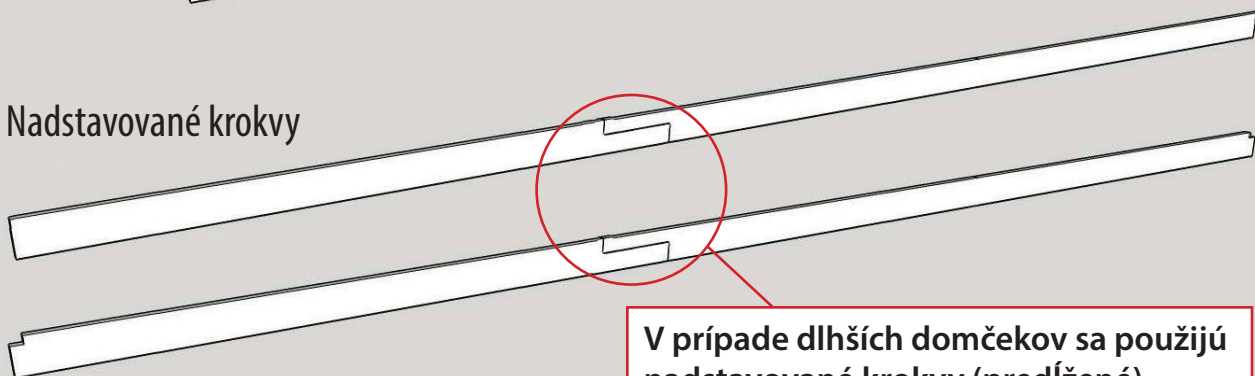

V prípade dlhších domčekov sa použijú nadstavované krokvy (predĺžené).

Bočná
krokva

Stredová
krokva

Bočná
krokva

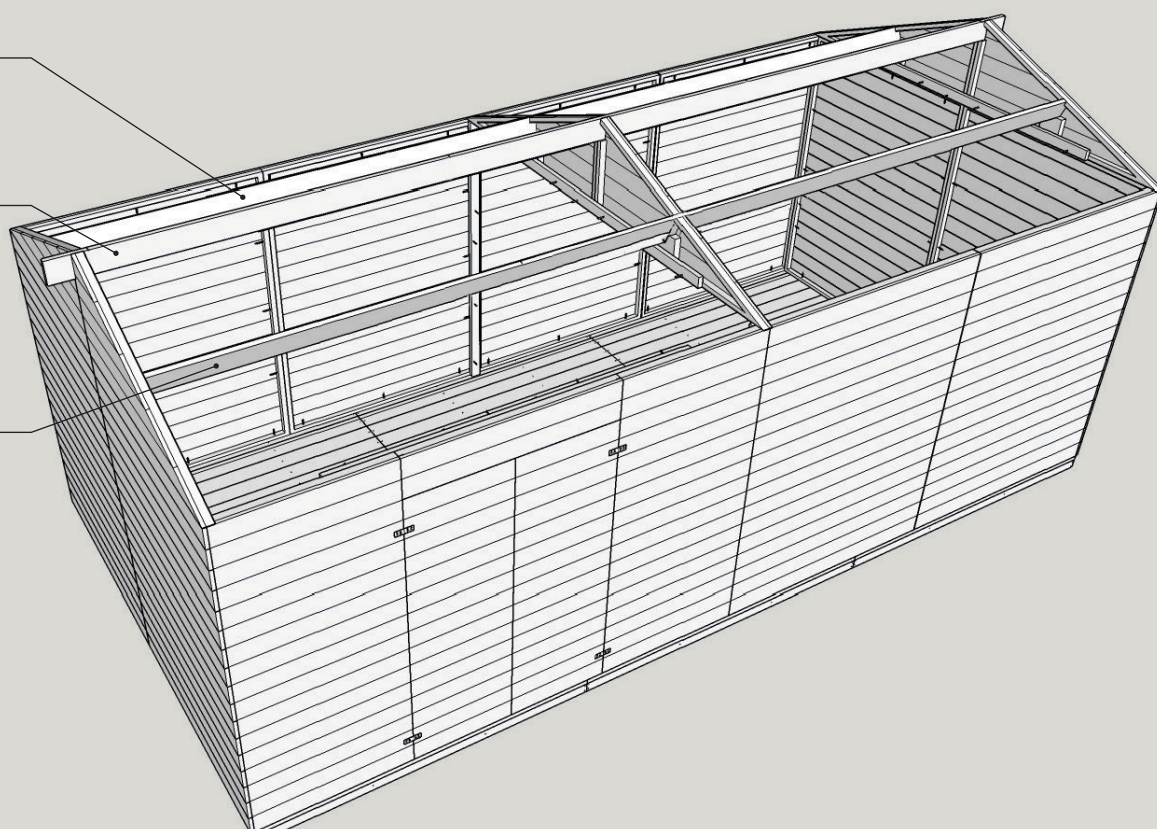

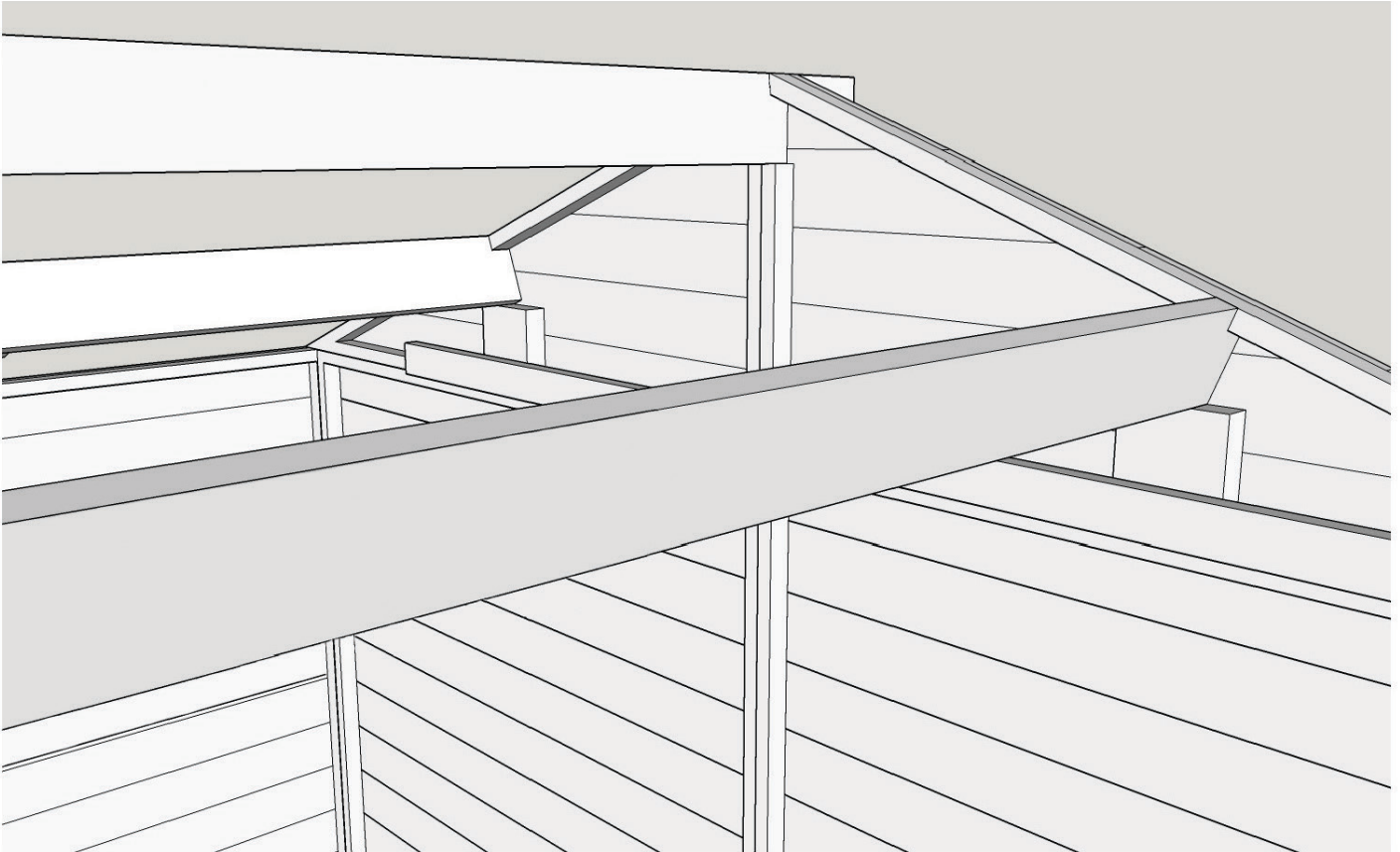

Uloženie pokrytia strechy

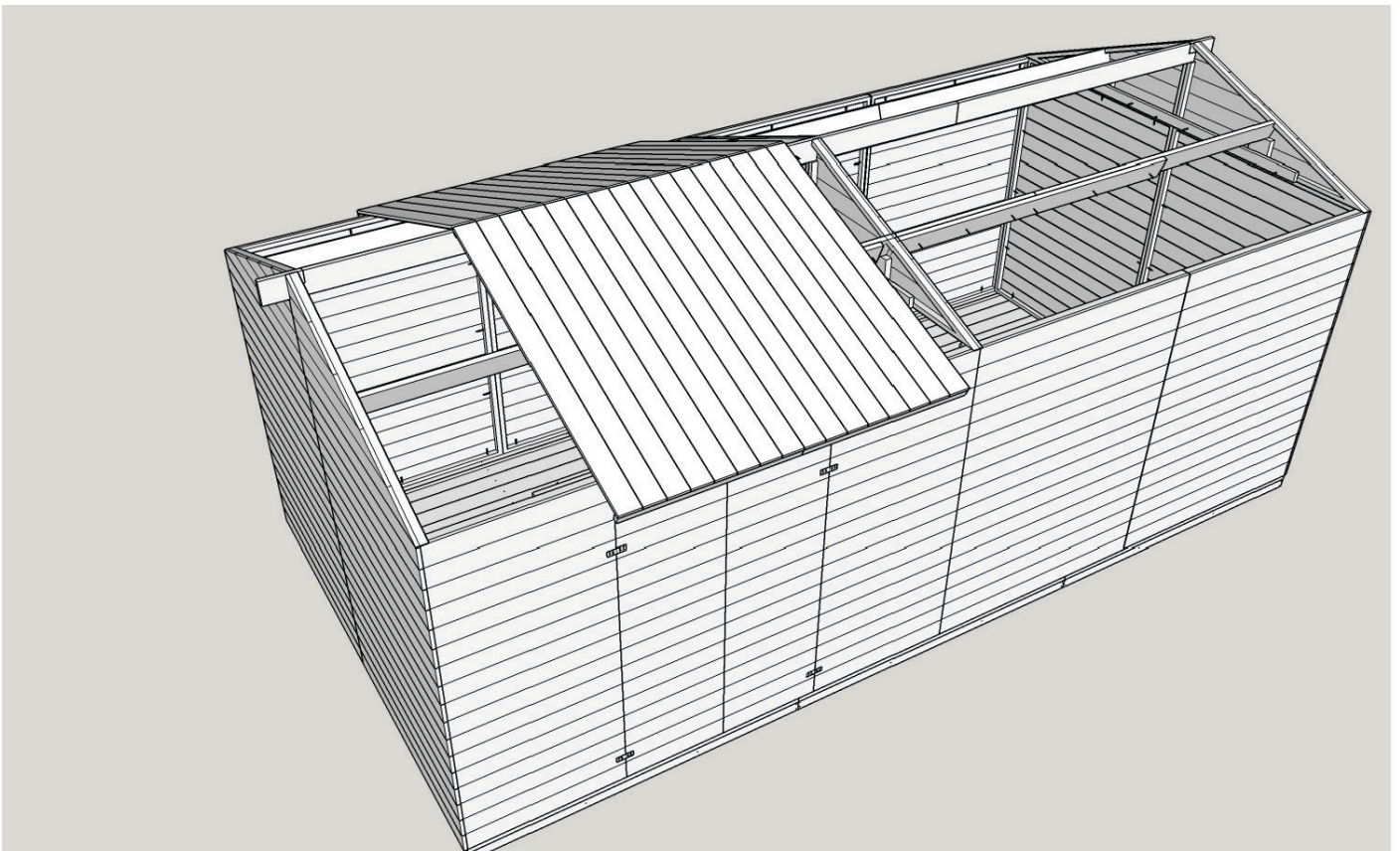

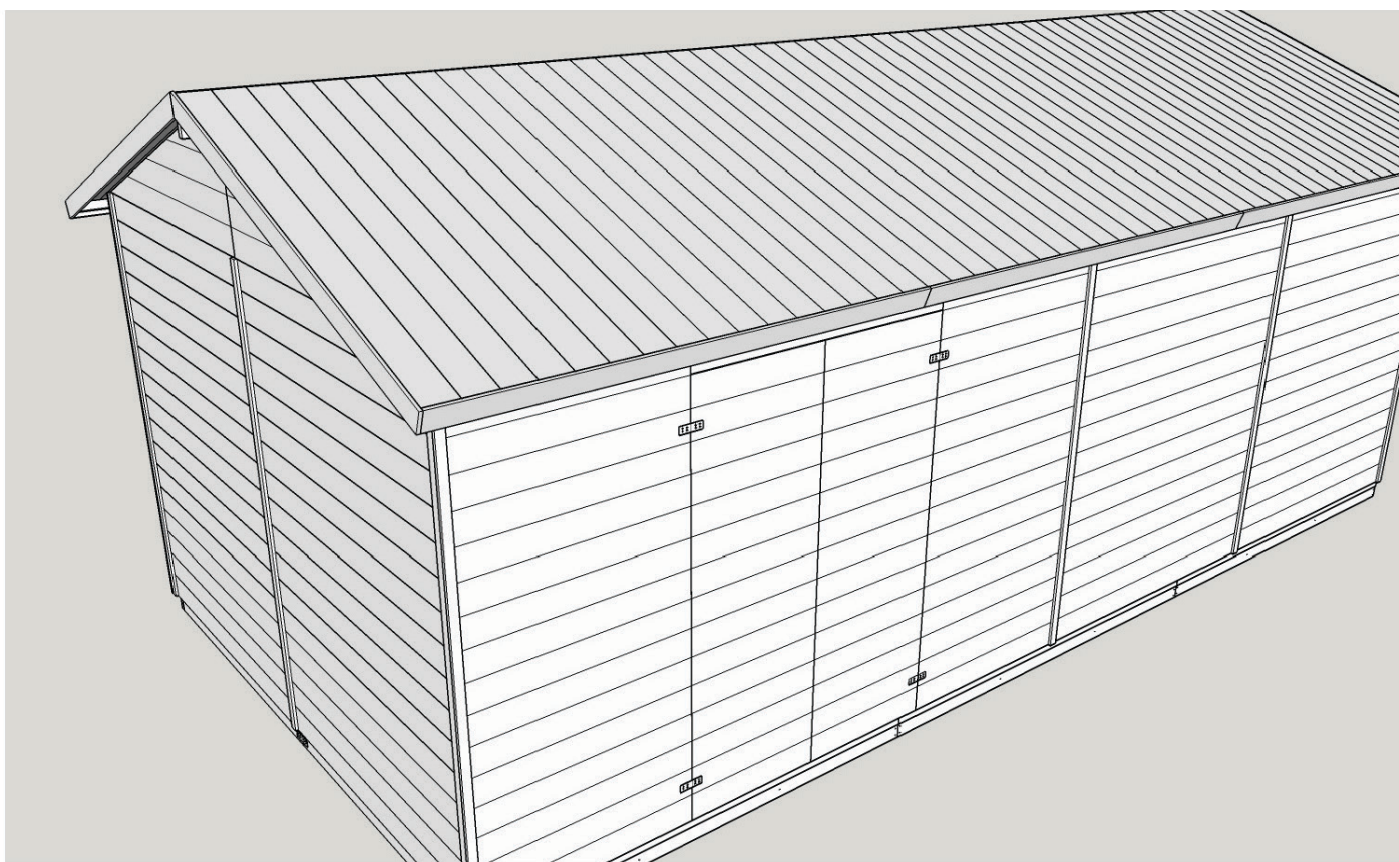
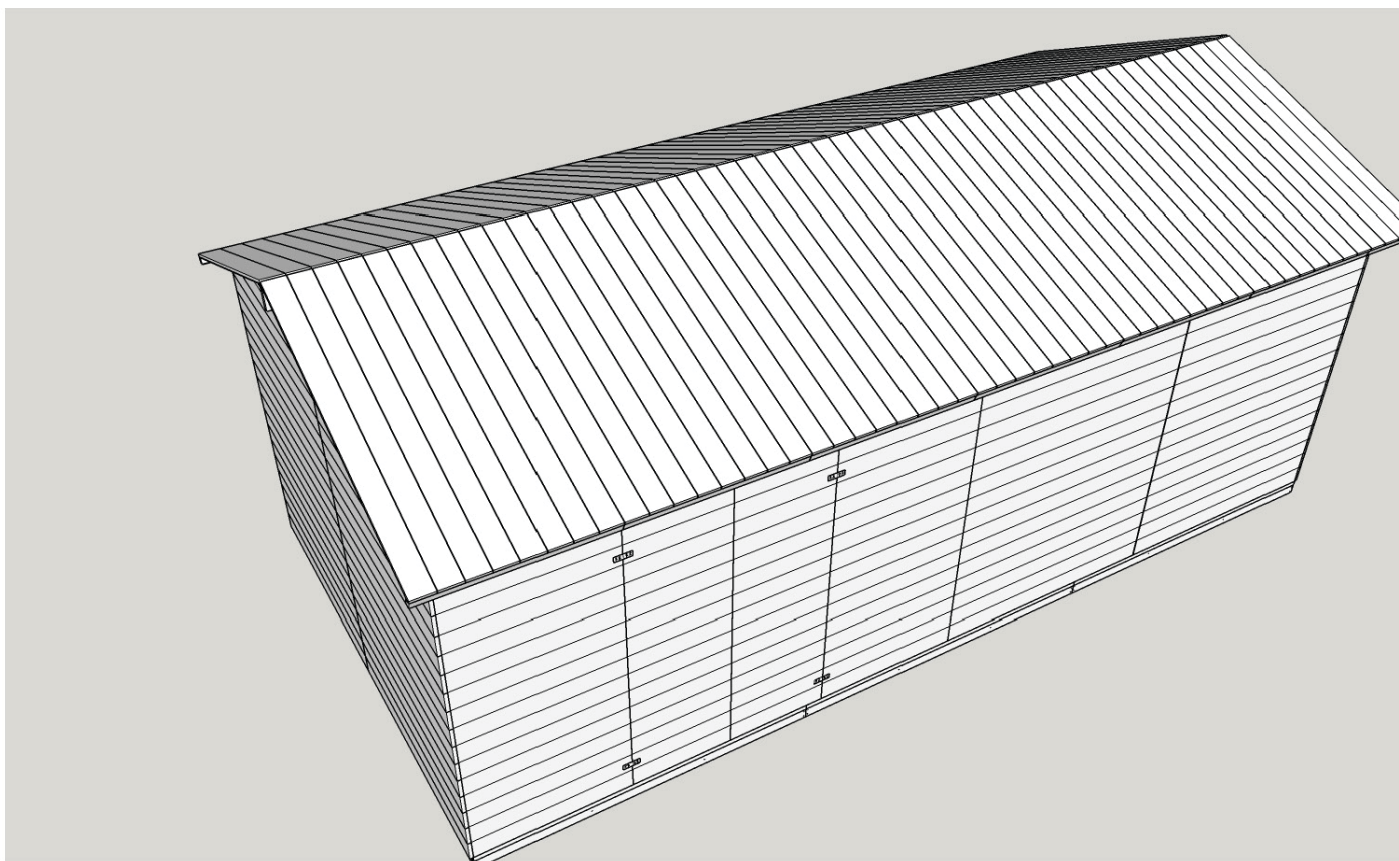

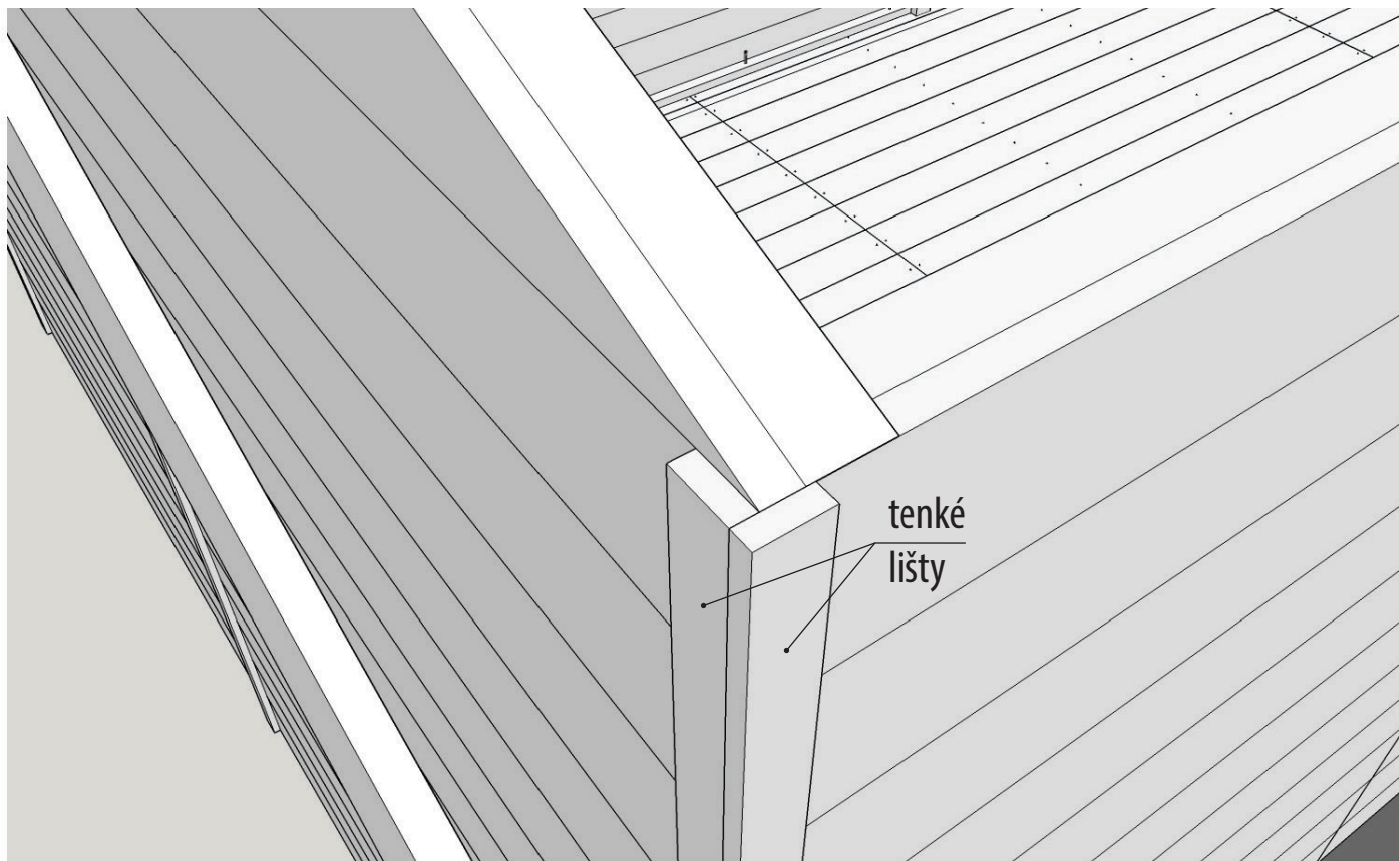

Postup pri kladení asfaltovej izolácie

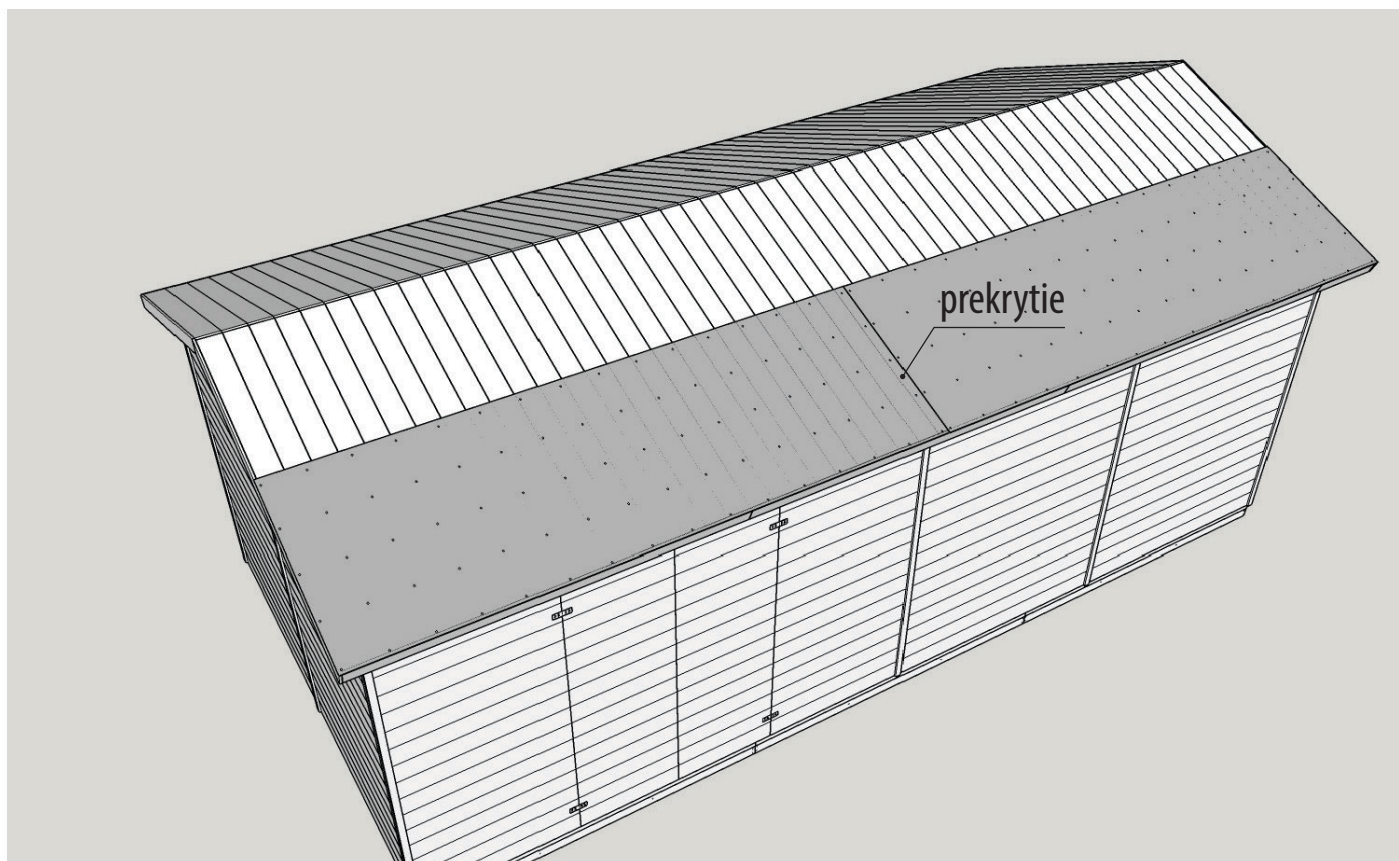

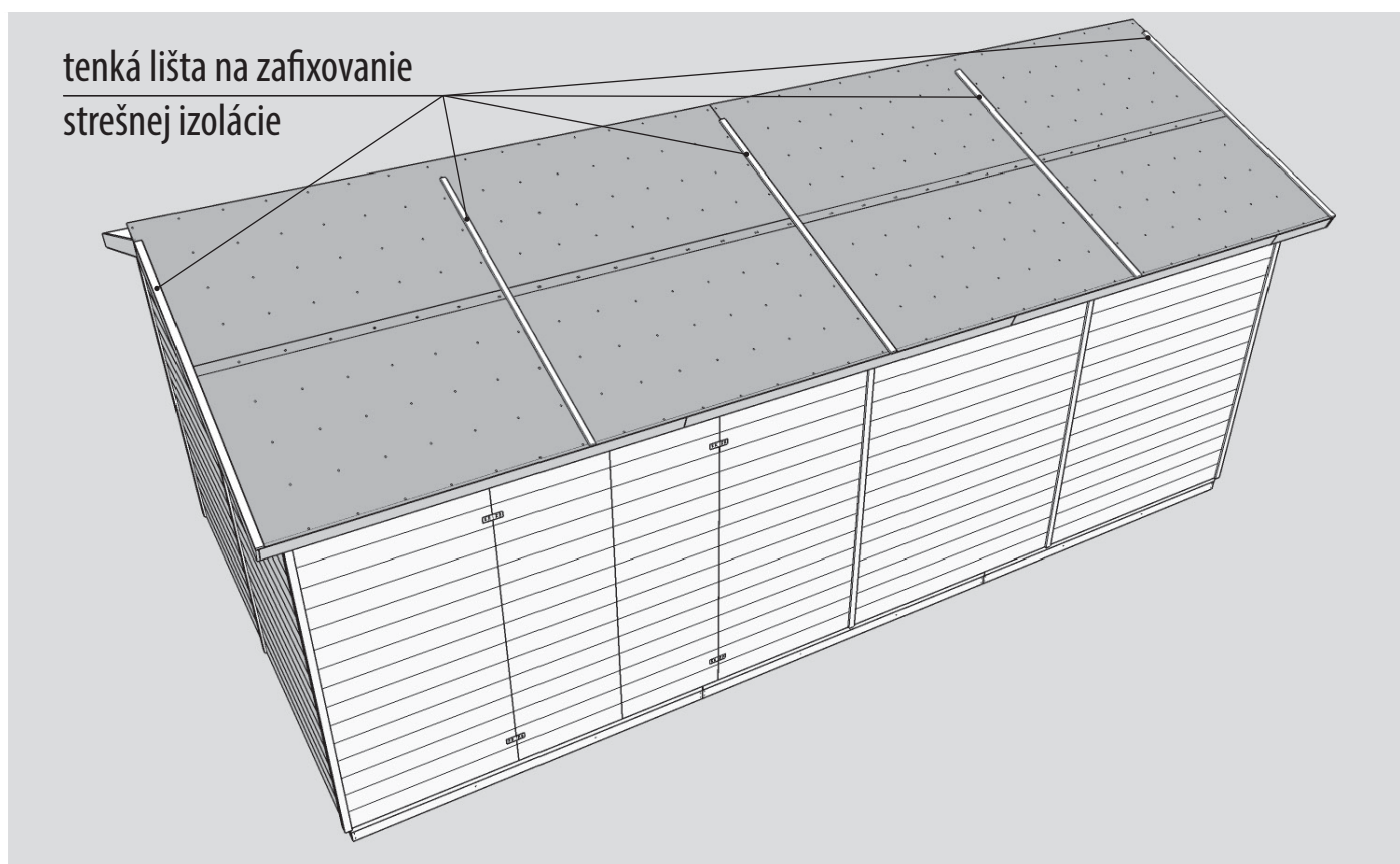
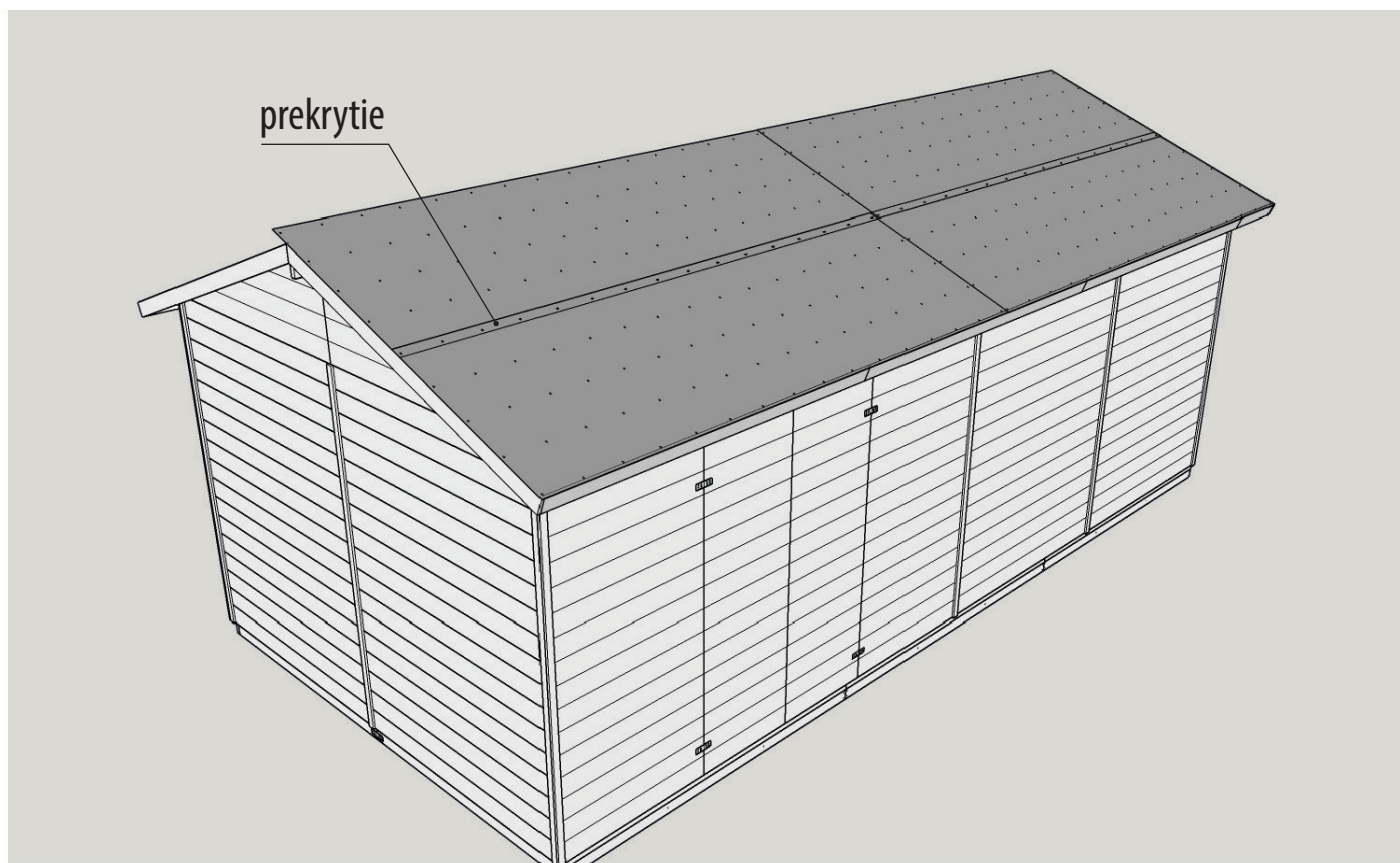

Ďakujeme za výber
záhradného domčeka z našej spoločnosti
a prajeme spokojné užívanie.

Záhradné domčeky
MICHAL ZELMAN

www.domceknazahradu.sk



DOMCEK
NAZAHRADU.SK